

7030-01260 KIT

For: 4136 Frame Rails/4137 Loft Ends



(Scan for instructional video)







Sedona Collection: Junior Loft

PARTS LIST

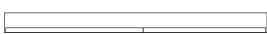
BOX 1: 4137 Sedona Junior Loft Ends

Part #	Picture	Description	Quantity
S0021END		Junior Loft Bed End	2

BOX 2: 4136 Sedona Junior Loft Frame

Part #	Picture	Description	Quantity
S0001SRL		5/4x6 Mattress Rail	2
541750001		5/4x4 Guard Rail	4
560750001		5/4x6 Support Rail	1
149383/40		Individual Twin Slat	3
5040-43181		Hex Lag Bolt/Washer	28
5040-35410		#6 x 1 1/4 Phil Flat Slat Screw	10

Make sure you have all parts before beginning assembly. If you need a part, contact Living Spaces

COMPLETED ASSEMBLY

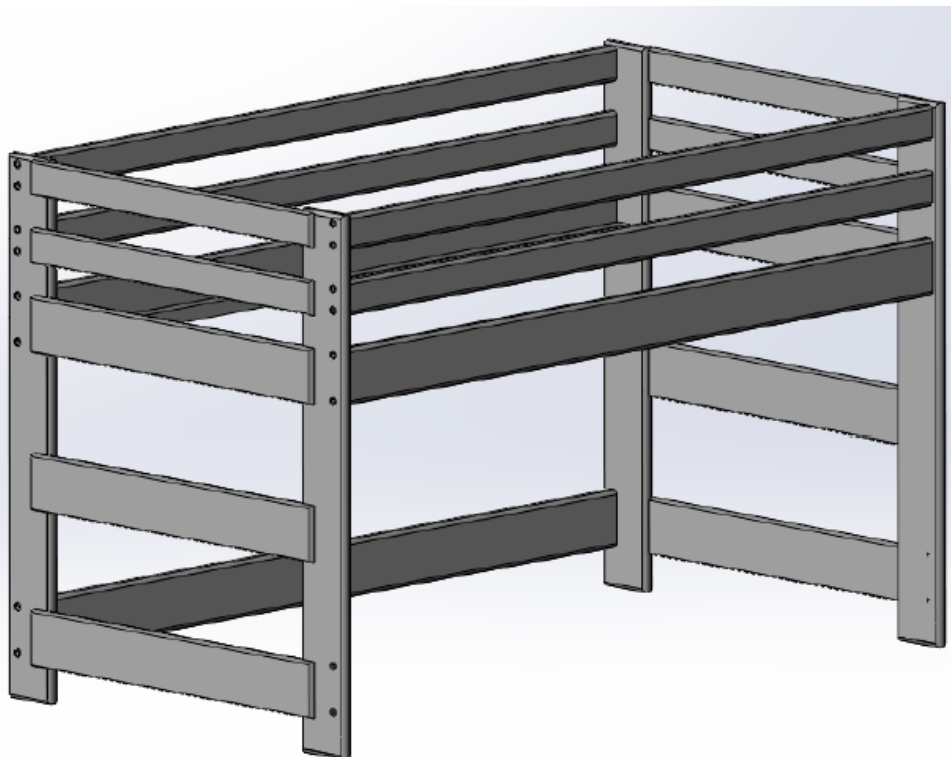

TOOLS REQUIRED:

- 1) 7/16" Wrench or Socket Wrench
- 2) Phillips Head Screwdriver

ASSEMBLY INSTRUCTIONS:

NOTE:

- 1) Attach the one support rail (560750001) to the bottom of the end assemblies (S0021END) with 4 lag bolts and 4 washers (5040-43181), and tighten.
- 2) Attach two mattress rails (S0001SRL) and four guard rails (541750001) to the top of the end assemblies with 24 lag bolts and 24 washers (5040-43181), and tighten.
- 3) Lay out your slat kit on the bed surface, resting on the mattress rail cleats, and place the 3 individual slats (149383/40) in accordance with the diagram on the last page of these instructions. Attach the 5 designated slats to the mattress rail cleats using the #6 x 1 1/4" screws (5040-35410).

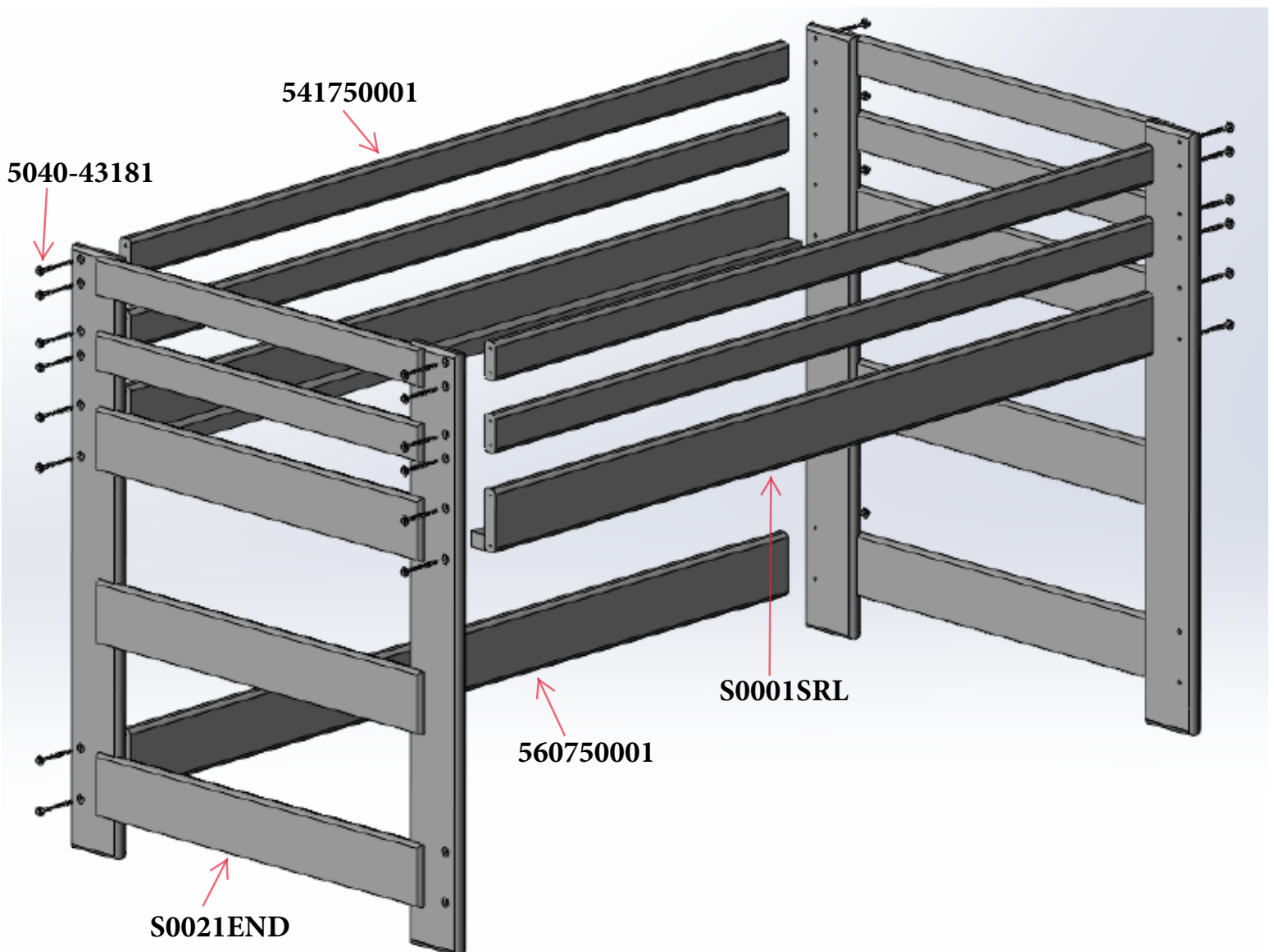

Optional Setup

BOX 1: 4492 Sedona Super Storage Dresser

Part #	Picture	Description	Quantity
4492		Sedona Super Storage Dresser	1

BOX 2: 4493 Sedona Stairway Chest

Part #	Picture	Description	Quantity
4493		Sedona Stairway Chest	1

One or both of the above optional pieces can be purchased to accentuate the Sedona Junior Loft as pictured below:

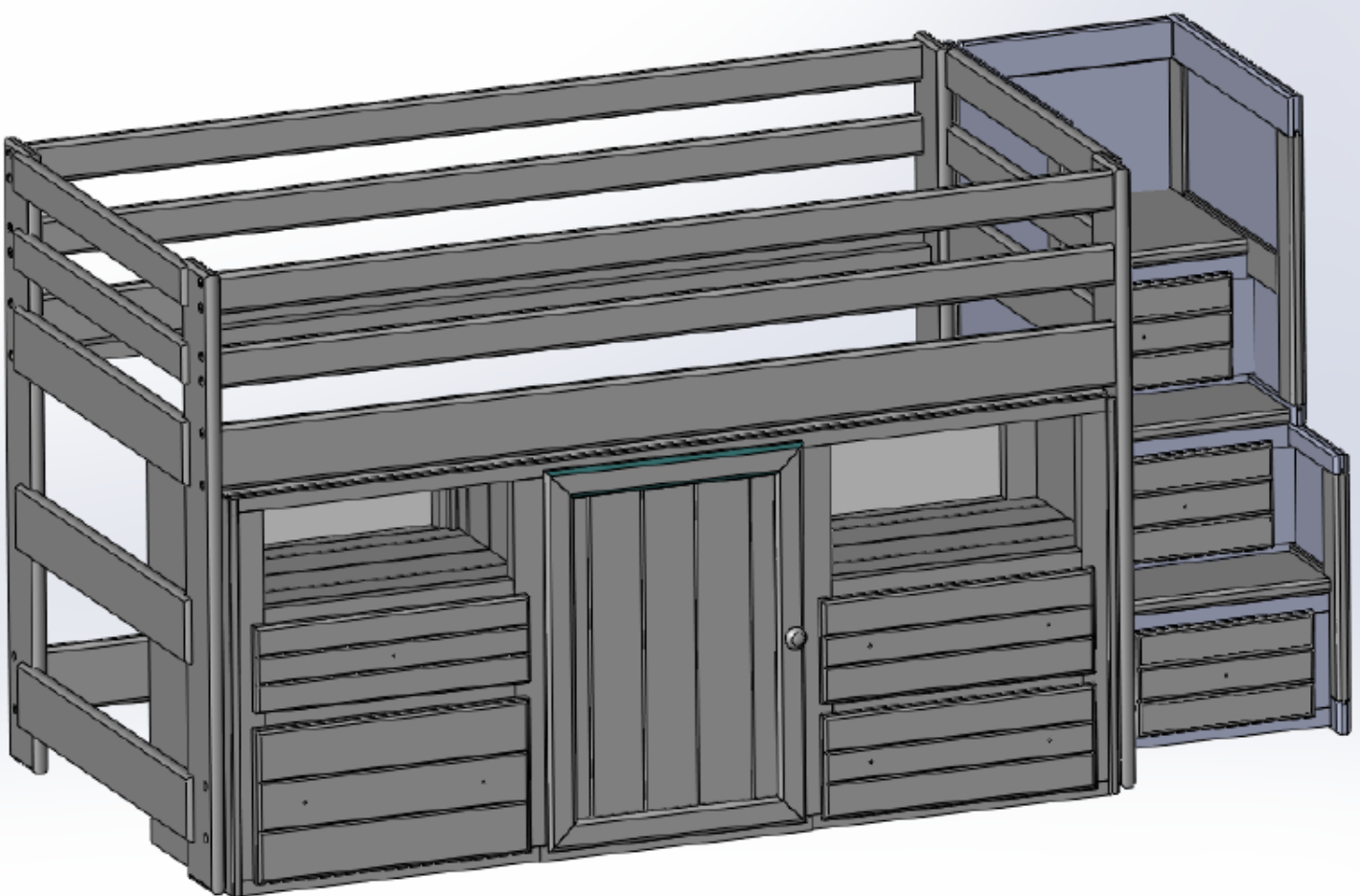

SAFETY WARNING

Our Bunk Beds have been tested by an Independent Laboratory and are certified to be in compliance with: ASTM F-1427, “Standard Consumer Safety Specification for Bunk Beds” and U.S. Government specifications 16 Code of Federal Regulations, parts 1213 and 1513.

SAFETY WARNINGS

1. Follow the information on the warnings attached to the upper bunk end structure and on the carton. Do not remove this label.
2. Always use the recommended size mattress or mattress support, or both, to help prevent the likelihood of entrapment or falls.
3. Top surface of mattress must be at least **five inches** (127mm) below the upper edge of top guard rails.
4. Do not allow children less than six years of age to use the upper bunk.
5. Periodically, check and ensure that the guardrail, ladder and other components are in their proper position, free from damage and that all connectors are tight.
6. Do not allow horseplay on or under the bed and prohibit jumping on the bed and ladder.
7. Prohibit more than one person on upper bunk.
8. Always use the ladder or bed end for entering and leaving the upper bunk.
9. Do not use substitute parts. Contact Living Spaces for replacement parts.
10. Use of a night-light may provide added safety precautions for a child using the upper bunk.
11. If the bunk bed will be placed next to a wall, the guardrail that runs the full length of the bed should be placed against the wall to prevent entrapment between the bed and the wall. (This applies only to bunk beds without two full-length guardrails.)
12. Always use guardrails on both long sides of the upper bunk.
13. The use of water or sleep flotation mattress is expressly prohibited.
14. Keep these instructions for future reference.

STRANGULATION HAZARD

15. Never attach or hang items to any part of the bunk bed that are not designed for use with the bed for example, but not limited to hooks, belts and jump ropes.

SIZE OF MATTRESS AND FOUNDATION

Your Twin bed is designed to use a mattress 37”-39” in width and 74” - 75” in length.

Your Full bed is designed to use a mattress 52”- 54” in width and 74” - 75” in length.

The total thickness of mattress and foundation (slat kit, bunk board, etc.) combined must not exceed **10”**.

Note: There must be at least 5” from mattress sleeping surface to top edge of guardrail.

REPLACEMENT PARTS

Replacement parts, including additional guardrails, may be requested from Living Spaces, usually at a cost.

Scan Code for Instructional video



Diagram 1

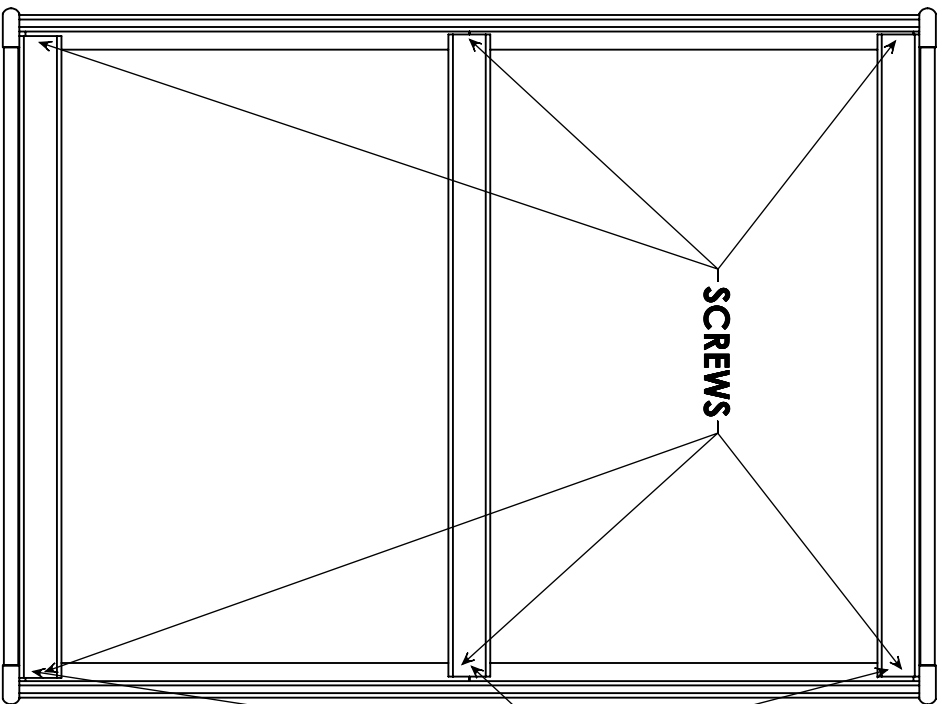

Installation of individual slats for use with Bunkie Board (Bunkie Board sold separately) See your retailer for purchase of Bunkie Board

When used with a slot roll, the three individual slats should be placed evenly in the gaps and underneath the strapping before fastening.

Diagram 2

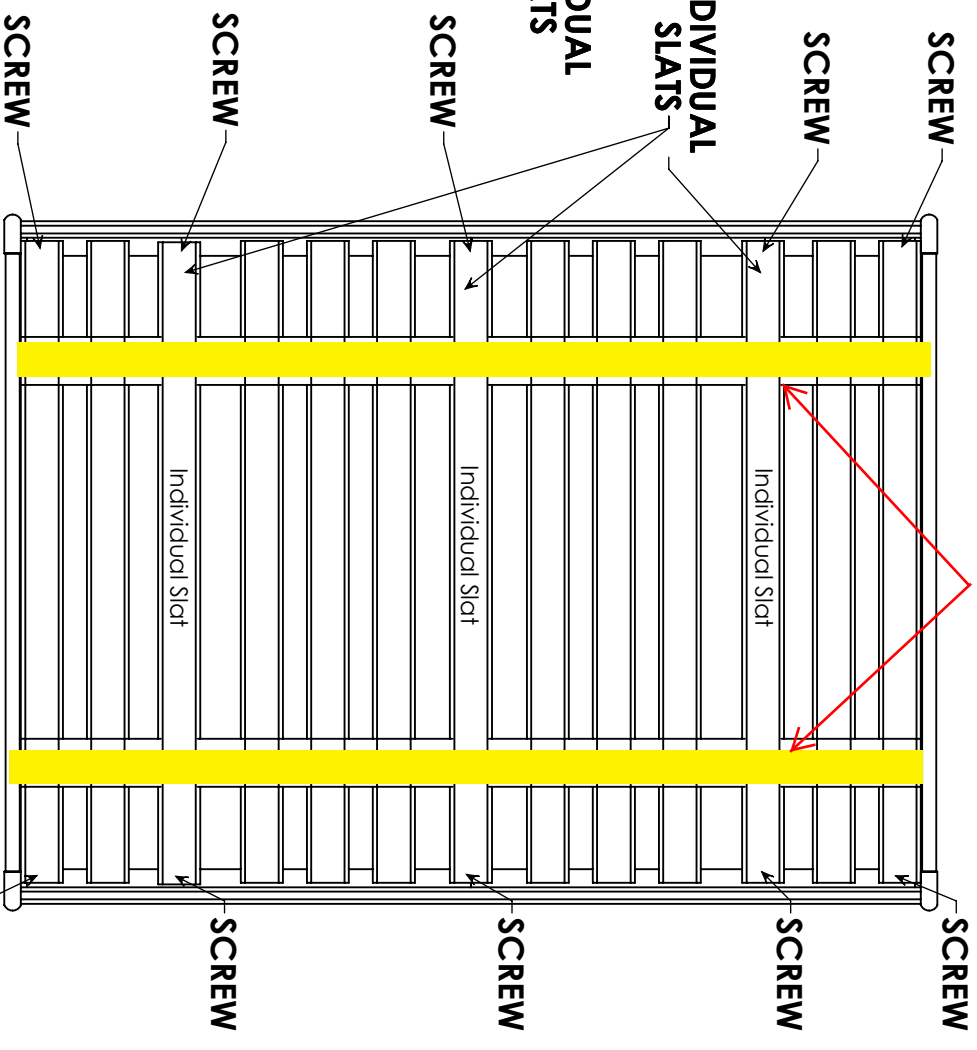

Installation of individual slats for use with Slot Roll (Slot roll sold separately) See your retailer for purchase of Slot Roll

7030-01195 KIT

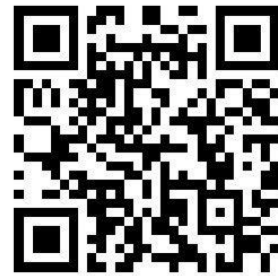

(Scan code for instructional video)

Sedona Collection: Knob Installation

1. Locate the box containing your knobs in the bottom drawer of your case good.
2. Identify which of the screw sizes is correct for your drawers/doors. The screw should protrude no more than 1/4" when pushed through the pre-drilled holes on your drawers/doors.
3. Push the screw through the back of the pre-drilled hole on the drawer/door and line it up with the thread on the back of the knob.
4. Tighten the screw into the back of the knob until the knob is tight against the front of your drawer/door.

****You can tighten your screws with either a phillips screwdriver, a drill with a phillips bit, or your hand****

