

# 7030-01260 KIT

For: 4136 Frame Rails/4137 Loft Ends



(Scan for instructional video)







## Sedona Collection: Junior Loft

### PARTS LIST

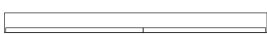
#### BOX 1: 4137 Sedona Junior Loft Ends

Part #	Picture	Description	Quantity
S0021END		Junior Loft Bed End	2

#### BOX 2: 4136 Sedona Junior Loft Frame

Part #	Picture	Description	Quantity
S0001SRL		5/4x6 Mattress Rail	2
541750001		5/4x4 Guard Rail	4
560750001		5/4x6 Support Rail	1
149383/40		Individual Twin Slat	3
5040-43181		Hex Lag Bolt/Washer	28
5040-35410		#6 x 1 1/4 Phil Flat Slat Screw	10

Make sure you have all parts before beginning assembly. If you need a part, contact Living Spaces

### COMPLETED ASSEMBLY

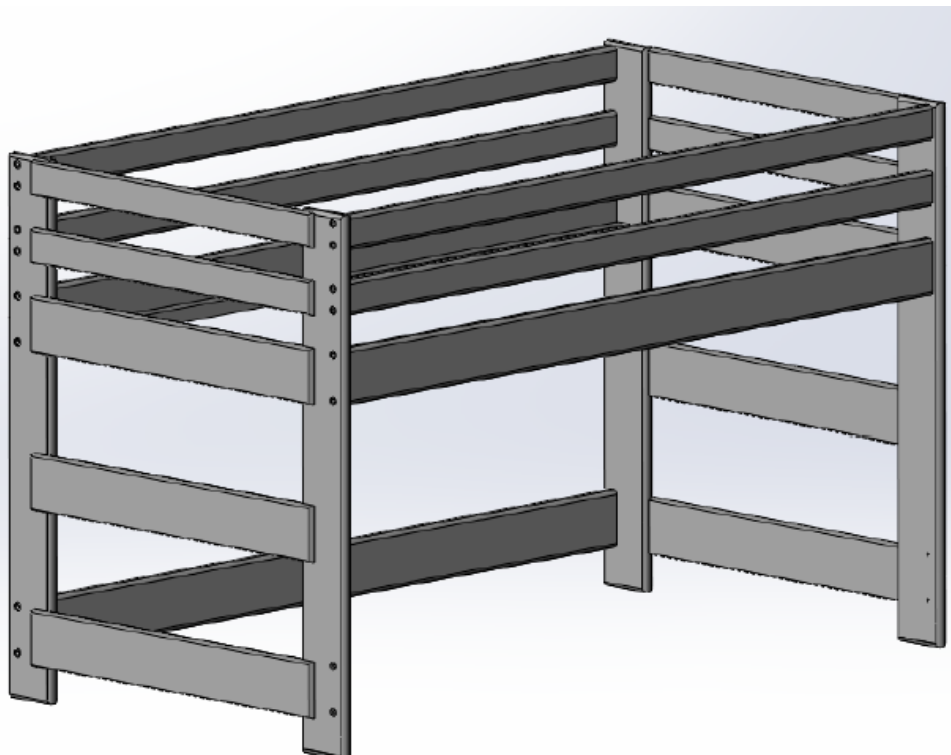

## **TOOLS REQUIRED:**

- 1) 7/16" Wrench or Socket Wrench
- 2) Phillips Head Screwdriver

## **ASSEMBLY INSTRUCTIONS:**

### **NOTE:**

- 1) Attach the one support rail (560750001) to the bottom of the end assemblies (S0021END) with 4 lag bolts and 4 washers (5040-43181), and tighten.
- 2) Attach two mattress rails (S0001SRL) and four guard rails (541750001) to the top of the end assemblies with 24 lag bolts and 24 washers (5040-43181), and tighten.
- 3) Lay out your slat kit on the bed surface, resting on the mattress rail cleats, and place the 3 individual slats (149383/40) in accordance with the diagram on the last page of these instructions. Attach the 5 designated slats to the mattress rail cleats using the #6 x 1 1/4" screws (5040-35410).

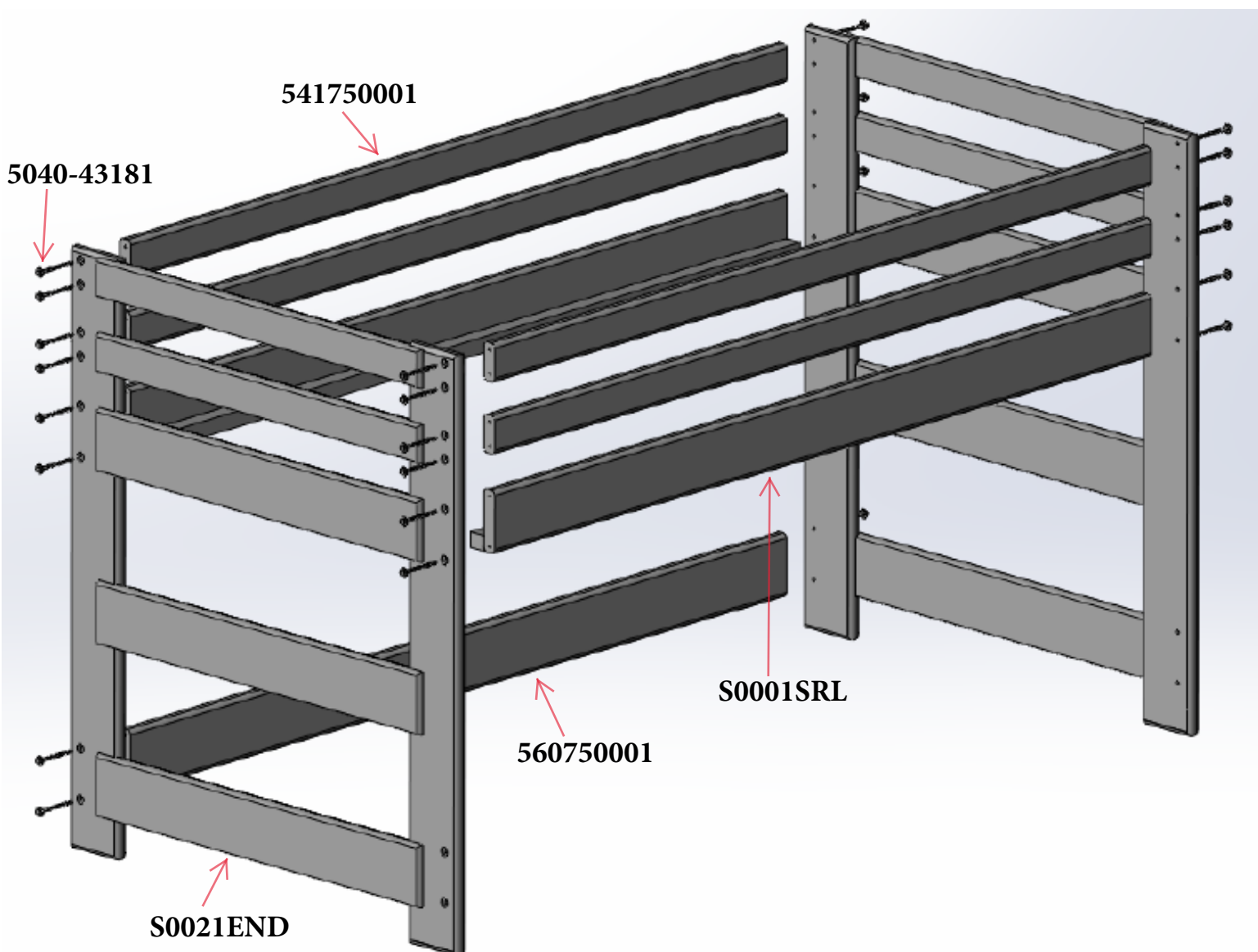

## Optional Setup

### BOX 1: 4492 Sedona Super Storage Dresser

Part #	Picture	Description	Quantity
4492		Sedona Super Storage Dresser	1

### BOX 2: 4493 Sedona Stairway Chest

Part #	Picture	Description	Quantity
4493		Sedona Stairway Chest	1

**One or both of the above optional pieces can be purchased to accentuate the Sedona Junior Loft as pictured below:**

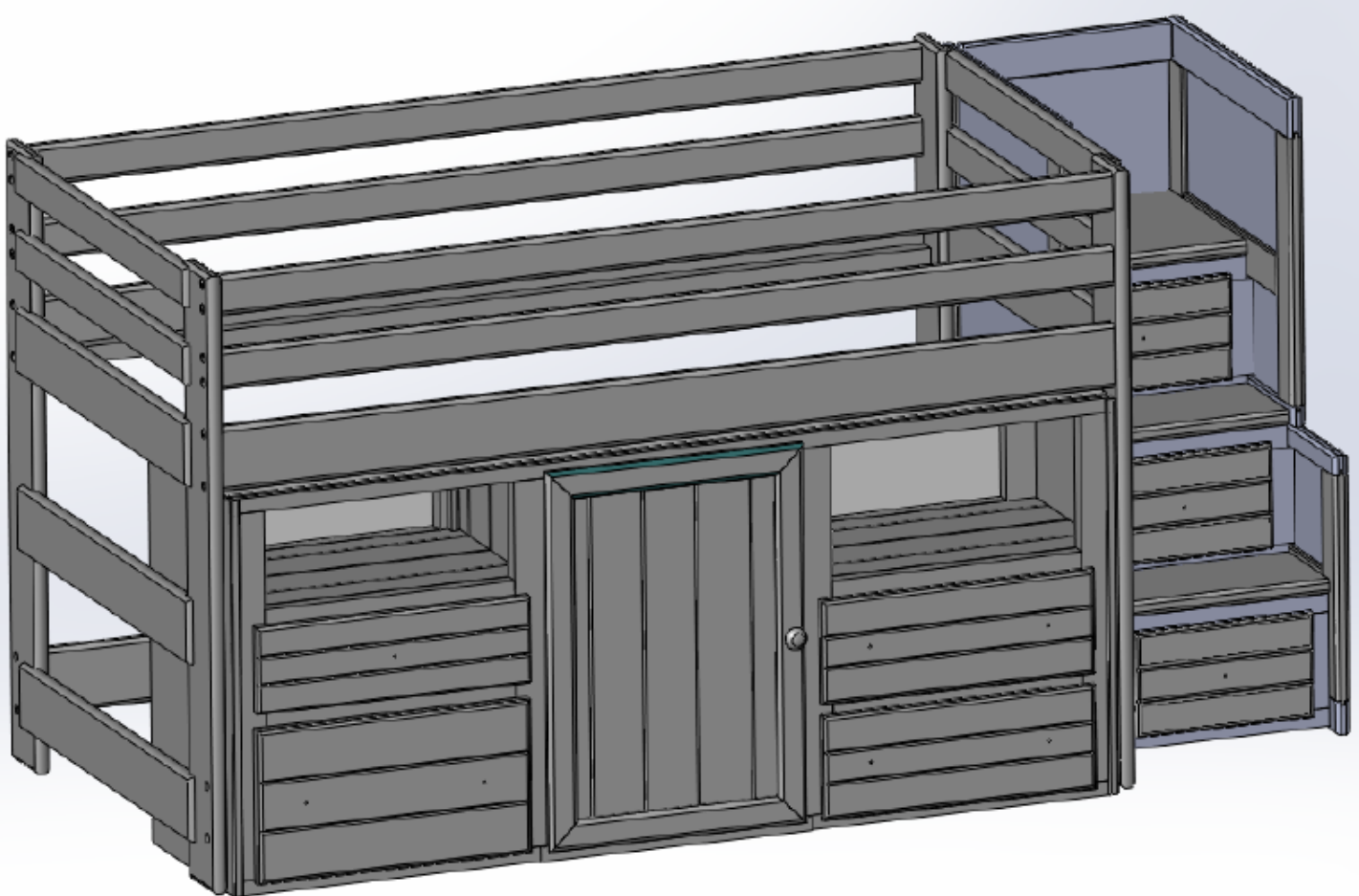

## **SAFETY WARNING**

Our Bunk Beds have been tested by an Independent Laboratory and are certified to be in compliance with: ASTM F-1427, “Standard Consumer Safety Specification for Bunk Beds” and U.S. Government specifications 16 Code of Federal Regulations, parts 1213 and 1513.

### **SAFETY WARNINGS**

1. Follow the information on the warnings attached to the upper bunk end structure and on the carton. Do not remove this label.
2. Always use the recommended size mattress or mattress support, or both, to help prevent the likelihood of entrapment or falls.
3. Top surface of mattress must be at least **five inches** (127mm) below the upper edge of top guard rails.
4. Do not allow children less than six years of age to use the upper bunk.
5. Periodically, check and ensure that the guardrail, ladder and other components are in their proper position, free from damage and that all connectors are tight.
6. Do not allow horseplay on or under the bed and prohibit jumping on the bed and ladder.
7. Prohibit more than one person on upper bunk.
8. Always use the ladder or bed end for entering and leaving the upper bunk.
9. Do not use substitute parts. Contact Living Spaces for replacement parts.
10. Use of a night-light may provide added safety precautions for a child using the upper bunk.
11. If the bunk bed will be placed next to a wall, the guardrail that runs the full length of the bed should be placed against the wall to prevent entrapment between the bed and the wall. (This applies only to bunk beds without two full-length guardrails.)
12. Always use guardrails on both long sides of the upper bunk.
13. The use of water or sleep flotation mattress is expressly prohibited.
14. Keep these instructions for future reference.

### **STRANGULATION HAZARD**

15. Never attach or hang items to any part of the bunk bed that are not designed for use with the bed for example, but not limited to hooks, belts and jump ropes.

### **SIZE OF MATTRESS AND FOUNDATION**

Your Twin bed is designed to use a mattress 37”-39” in width and 74” - 75” in length.

Your Full bed is designed to use a mattress 52”- 54” in width and 74” - 75” in length.

The total thickness of mattress and foundation (slat kit, bunk board, etc.) combined must not exceed **10”**.

Note: There must be at least 5” from mattress sleeping surface to top edge of guardrail.

### **REPLACEMENT PARTS**

Replacement parts, including additional guardrails, may be requested from Living Spaces, usually at a cost.

Scan Code for Instructional video



Diagram 1

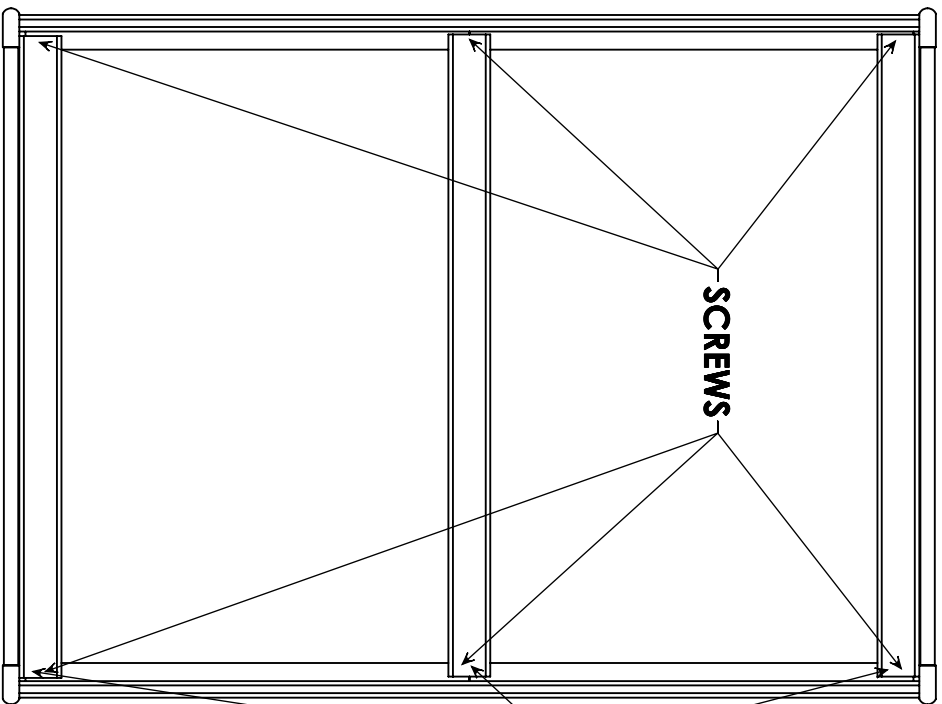

Installation of individual slats for use with Bunkie Board (Bunkie Board sold separately) See your retailer for purchase of Bunkie Board

When used with a slot roll, the three individual slats should be placed evenly in the gaps and underneath the strapping before fastening.

Diagram 2



Installation of individual slats for use with Slot Roll (Slot roll sold separately) See your retailer for purchase of Slot Roll

# 7030-01280 KIT

For: 4798 Frame Rails/4799 Caster Ends





(Scan for instructional video)





## Sedona Collection: Bronco Caster Bed

### PARTS LIST

#### BOX 1: 4799 Bronco Caster Ends

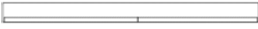
Part #	Picture	Description	Quantity
S0040END		Bronco Caster End Assembly	2
5045-65303		Caster Wheel	4
5045-65301		Caster Wheel Insert	4

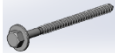
#### BOX 2: 4798 Bronco Caster Frame

Part #	Picture	Description	Quantity
S1001SRL		5/4 x 6 x 75 Mattress Rail	2
149383/40		Twin Individual Slat	3
5040-43181		Hex Lag Bolt/Washer	8
5040-35410		#6 x 1 1/4 Phil Flat Slat Screw	10

**Make sure you have all parts before beginning assembly. If you need a part, contact Living Spaces**

## COMPLETED ASSEMBLY

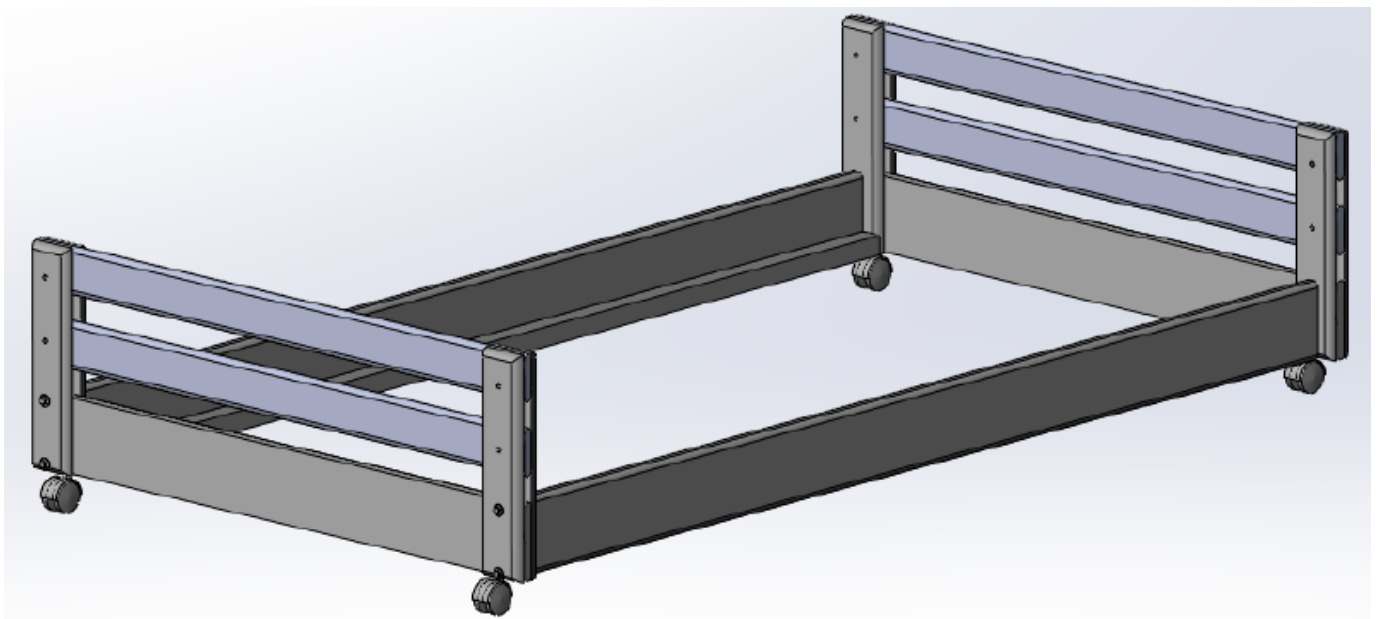

## TOOLS REQUIRED:

- 1) 7/16" Wrench or Socket Wrench
- 2) Phillips Head Screwdriver

NOTE: Tool recommended: Electric driver with 7/16" socket

## ASSEMBLY INSTRUCTIONS:

### NOTE:

Make sure you have all parts before beginning assembly. If you need a part, contact the dealer where you purchased your bed.

1) Attach two mattress rails (S1001SRL) to end assemblies(S0040END) with 8 lag bolts and 8 washers (5040-43181), and tighten. Use either the top set of holes or bottom set of holes depending on preference.

2) Attach the caster wheels (5045-65303) to the end assemblies using the pre-drilled holes on the bottom. Be sure to insert the caster wheel inserts (5045-65301) first, and then insert the caster wheel stems into the inserts pushing them in fully. *\*\*Attempting to drive the inserts in with the caster wheels attached may cause damage to the wheels\*\**

3) Place slat kit (purchased separately) and 3 individual slats (149383/40) in accordance with the diagram on the last page of these instructions. Attach the 5 designated slats to the mattress rail cleats using the #6x1 1/4" screws (5040-35410).

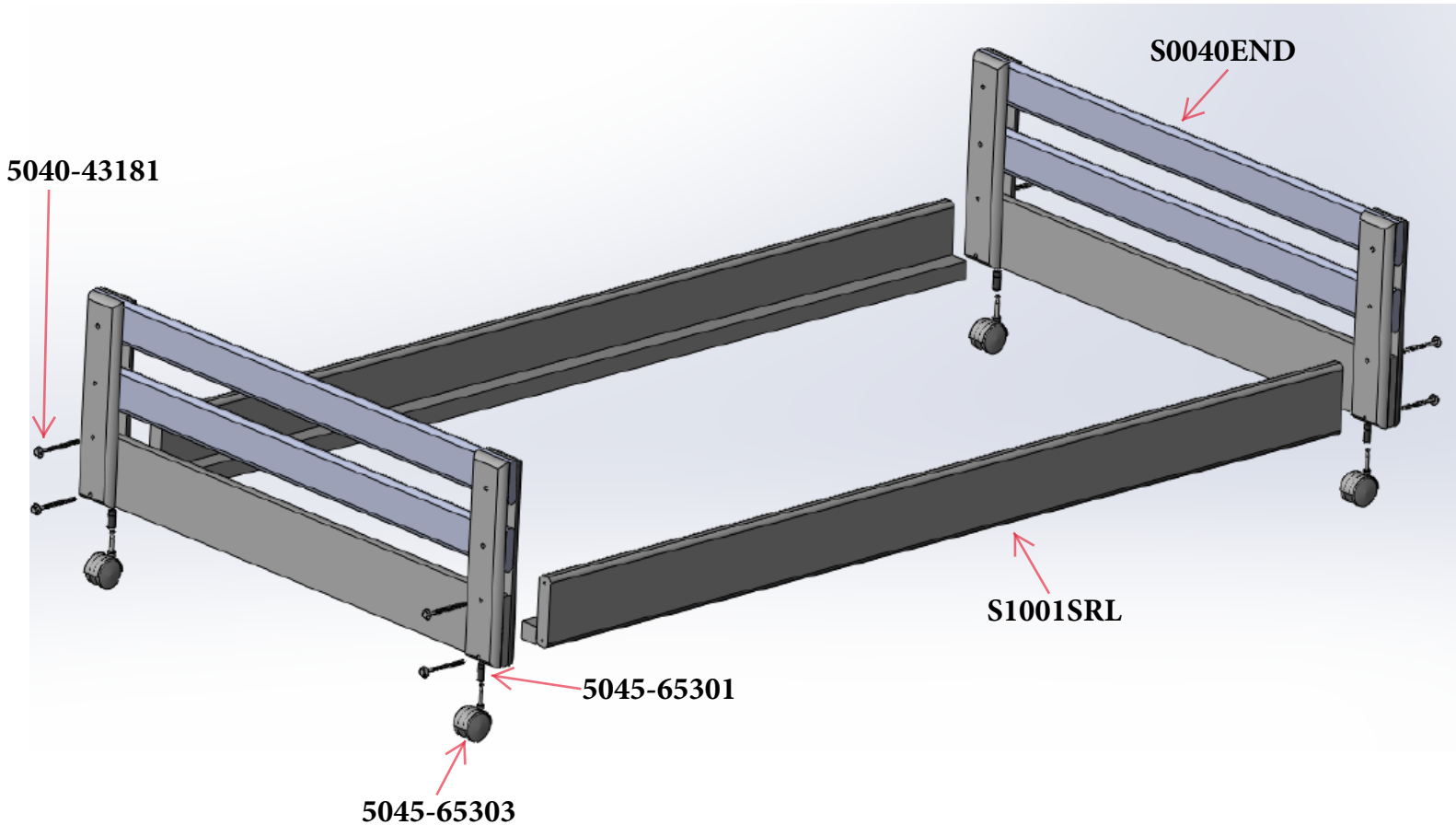

Scan Code for Instructional video



Diagram 1

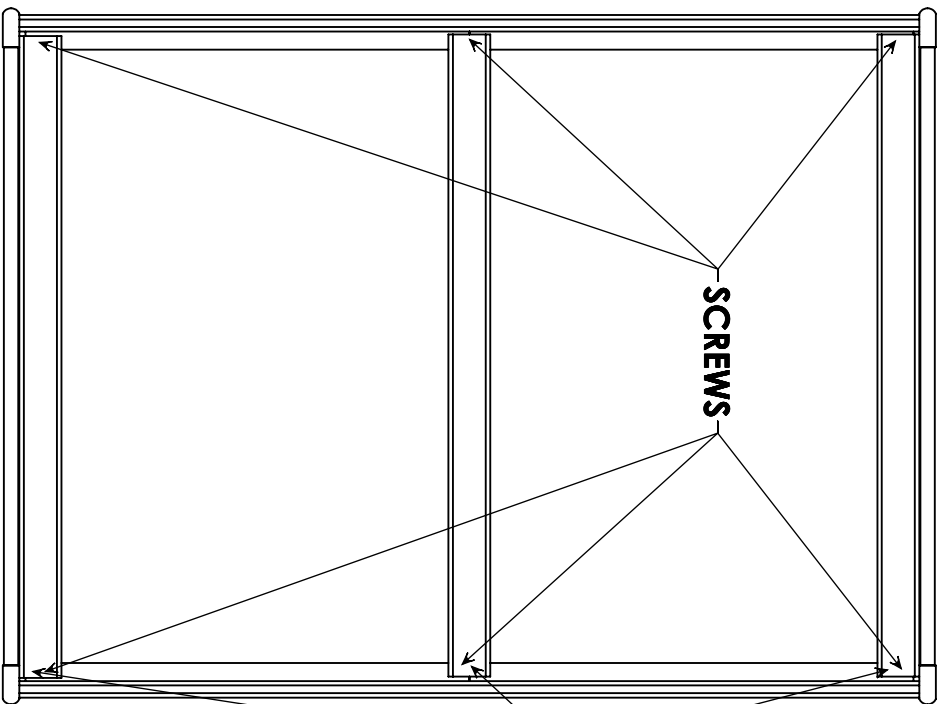

Installation of individual slats for use with Bunkie Board (Bunkie Board sold separately) See your retailer for purchase of Bunkie Board

When used with a slot roll, the three individual slats should be placed evenly in the gaps and underneath the strapping before fastening.

Diagram 2



Installation of individual slats for use with Slot Roll (Slot roll sold separately) See your retailer for purchase of Slot Roll