

LIVING SPACES







OWNER'S MANUAL

JAXON GREY WINE CABINET
LIVING SPACES SKU : 202298
VENDOR ITEM NO. : 7YU674









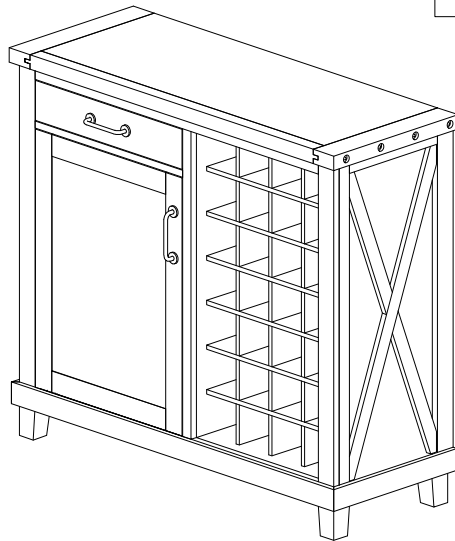

Scan QR code to view assembly video

ASSEMBLY PARTS LIST

SKU #	IMAGE	DESCRIPTION	QUANTITY	HARDWARE KIT PACKED IN BOX			
				SKU #	IMAGE	DESCRIPTION	QUANTITY
202298		WINE CABINET	1	7YZZCPHW-1		ALLEN BOLT (M6 X 50MM)	4
7YU6CPLG		LEGS	4	7YZZCPHW-2		FLAT WASHER (M6)	4
7YU674CL		CENTER SUPPORT LEG	1	7YZZCPHW-3		ALLEN KEY	1
FULLY ASSEMBLED				RPZZCPTRDQP		TIPPING RESTRAINT	1

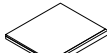

PRE-ASSEMBLED PARTS LIST

SKU #	IMAGE	DESCRIPTION	SKU #	IMAGE	DESCRIPTION
7YZZCPHLS		SMALL HANDLE	7YZZ74DG		DRAWER GLIDE SET
7YZZ84GMG		DOOR MAGNET	7YZZ74HG		DOOR HINGE
7YU674SH		SHELF	RPZZCPSSP		SHELF SUPPORT PIN
7YZZCPFC18		FOOT CAP	7YZZCPBTS		SMALL DECORATIVE BOLT

LIVING SPACES

OWNER'S MANUAL

JAXON GREY WINE CABINET
LIVING SPACES SKU : 202298
VENDOR ITEM NO. : 7YU674



Scan QR code to view assembly video

ASSEMBLY INSTRUCTIONS



Not provided

<p>1 7YU6CPLG 7YU674CL</p> <p>x4</p> <p>202298</p> <p>7YZZCPHW-3</p> <p>7YZZCPHW-1</p> <p>7YZZCPHW-2</p>	<p>2</p>	<p>3</p>
<p>4</p>	<p>5</p>	<p>6</p>

ASSEMBLY COMPLETE

LIVING SPACES

OWNER'S MANUAL

JAXON GREY WINE CABINET
LIVING SPACES SKU : 202298
VENDOR ITEM NO. : 7YU674



Scan QR code to view assembly video



WARNING:

- Maximum distributed load capacity: 195 lbs.
- Drawer capacity: 50 lbs. per drawer.
- Sitting, standing or jumping on this product may result in damage or injury.
- Injuries and damage can occur from furniture tip over if product is not properly anchored to the wall. Use the Furniture Tipping Restraint provided with the product. If the Furniture Tipping Restraint kit is not in the box, please contact our customer service department in order to obtain another kit before using the furniture.

ROUTINE MAINTENANCE:

Periodically check all fittings and tighten if necessary, as they can loosen over time.

CARE AND CLEANING:

SOLID WOOD FURNITURE

Congratulations on purchasing this handcrafted solid wood furniture product. Please keep in mind that wood is sensitive to changes in humidity. As the weather changes so does the relative humidity in your home and the moisture content of your solid wood furniture. We have taken every precaution to stabilize the lumber used to build this product. Still, you may observe plank movement or small cracks as the seasons change, particularly during the first 6-12 months of ownership. This is normal for solid wood furniture and will not affect the performance or longevity of this product.

Dust frequently with a clean, damp, lint-free cloth. Frequent dusting will remove abrasive build-up which can damage a finish over time. Avoid using oily polishes or waxes. Avoid exposing your furniture to strong sunlight. Prolonged exposure to direct sunlight can fade the finish of your furniture. Do not expose your furniture to any liquids. Never allow water to sit on your furniture. Do not place hot items on top of surface, always use a mat or other protector. Alcohol, nail polish and perfume are also dangerous, as they can dissolve the furniture finish on contact and may require professional repairs.