



Important safety instructions:

- Please read carefully all instructions before assembly.
- For your safety and ease, assembly by two or more adults is recommended.
- Keep instructions for future use.

Pre-assembly:

- Do not discard any content until assembly is complete to avoid accidentally discarding small parts or hardware.
- Take out all parts and hardware from box.

Parts List

Item	Description		QTY
P1	Front legs		2
P2	Back legs		2
P3	Chair top		1

Hardware List



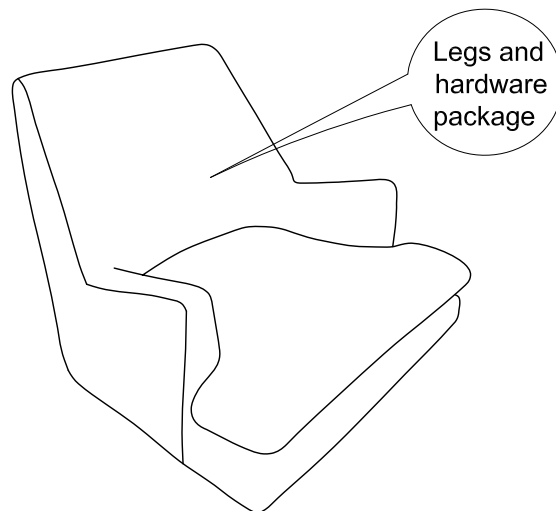

Item	Description		QTY
H1	Bolts M8 x 30mm		12
H2	Lock Washers 8		12
H3	Flat Washers 8		12
H4	Allen Wrench		1

Assembly Procedures:

Step 1: Assemble the chair on a flat, soft surface such as a carpet or cloth to prevent scratching the finish. Remove the legs and hardware package from the chair .



Step 2: Attach front leg (P1) and back legs (P2) to chair top (P3) using Lock washers (H2), Flat washers (H3) and Bolt (H1) as shown below.

- (H1)x12 Bolts M8 x 30mm 
- (H2)x12 Lock Washers 8 
- (H3)x12 Flat Washers 8 
- (H4)x1 Alen Wrench 

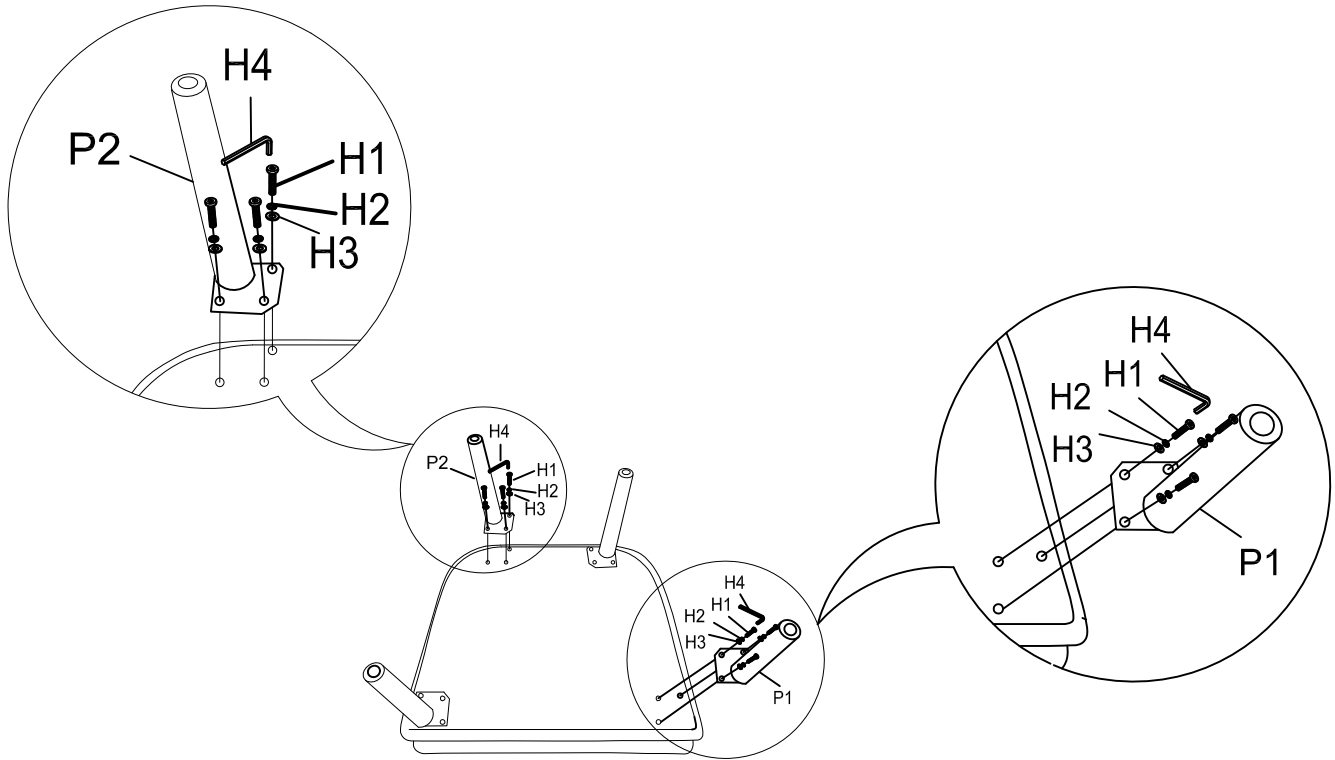

Step 3: Turn the assembled chair to an upright position. Assembly is complete.

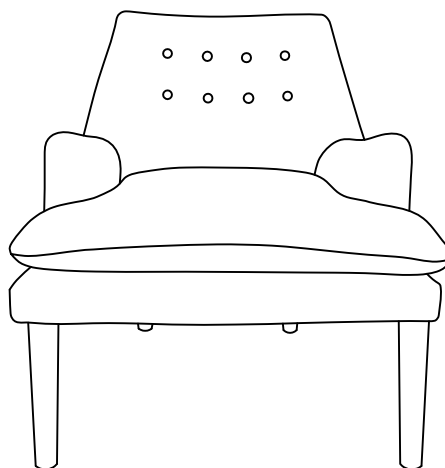

ADDITIONAL NOTE ABOUT SAFETY: BOLTS MAY LOOSEN DURING NORMAL EVERYDAY USE. THEY SHOULD BE PERIODICALLY INSPECTED AND RE-TIGHTENED TO PREVENT DAMAGE OR INJURY. ALWAYS CHECK TO ENSURE THAT ALL HARDWARE IS KEPT TIGHTENED.

Thank you for your purchase