



LIVING SPACES

ASSEMBLY INSTRUCTIONS

ITEM 305-P335160 / 161 / 152

6/6 BED

Thank you for purchasing this quality product. Be sure to check all packing material carefully for small hardware which may have come loose inside the carton during shipment. Identify and count all hardware and compare with the hardware list below.

When placing furniture on non-carpeted flooring, HMI recommends the use of floor protection such as an area rug or furniture pads. Area rugs and padding not included with purchase.

PARTS LIST

No.	Description	Sketch	Q.ty
1	Headboard Panel		1
2	Headboard Leg (Left & Right)		2
3	Footboard		1
4	Slat		5
5	Slat Support Leg		10
6	Side Rail		2

HARDWARE LIST

No.	Description	Sketch	Size	Q.ty
A	Allen bolt		1/4 " x 1-9/16"	10
B	Lock washer		1/4 "	10
C	Flat washer		1/4 " x 3/4"	10
D	Allen key		4mm	1
E	Wood screw		M4 x 1-1/4"	10

TOOLS REQUIRED (NOT PROVIDED)

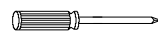

PHILLIPS HEAD SCREWDRIVER

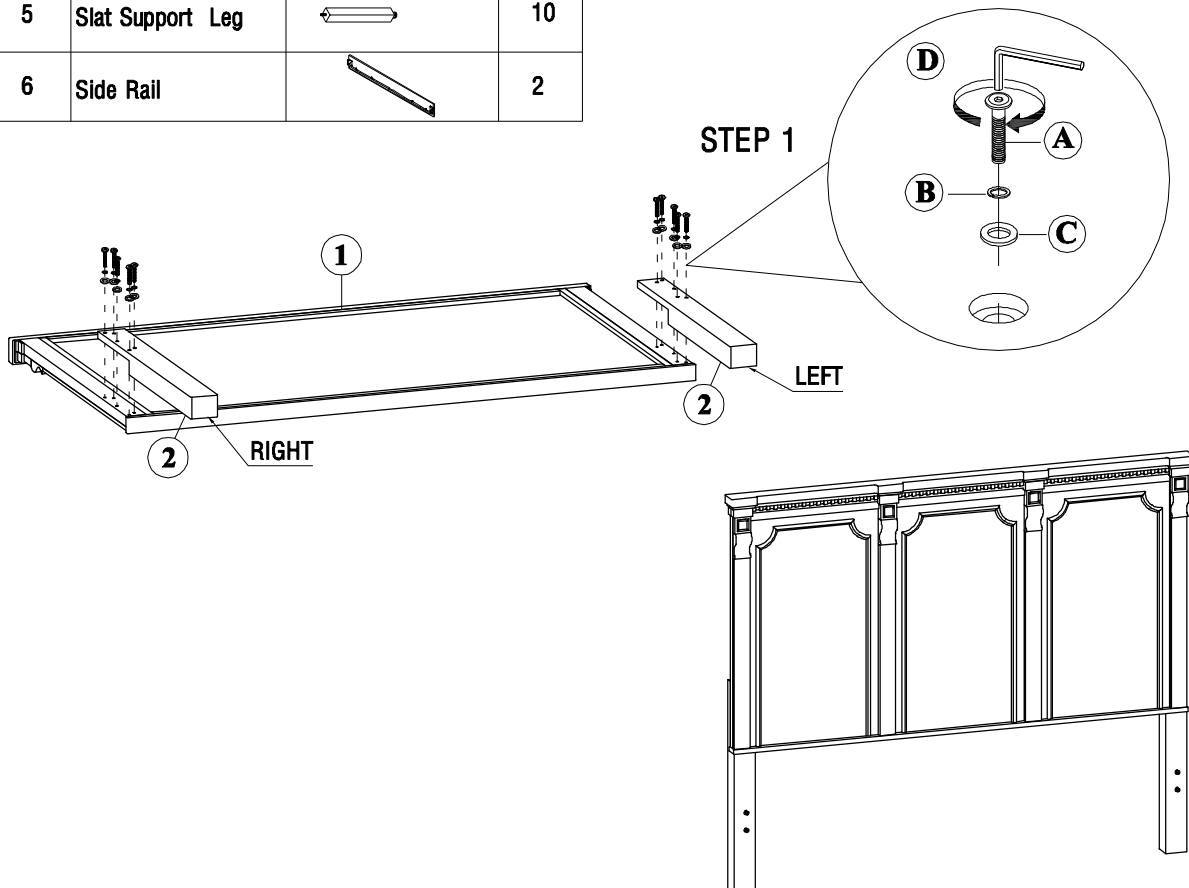



LIVING SPACES

ASSEMBLY INSTRUCTIONS

ITEM 305-P335160 / 161 / 152

6/6 BED

* USE ALLEN KEY LOOSEN BOLTS THEN ATTACH RAILS AND FULLY TIGHTEN ALL THE BOLTS

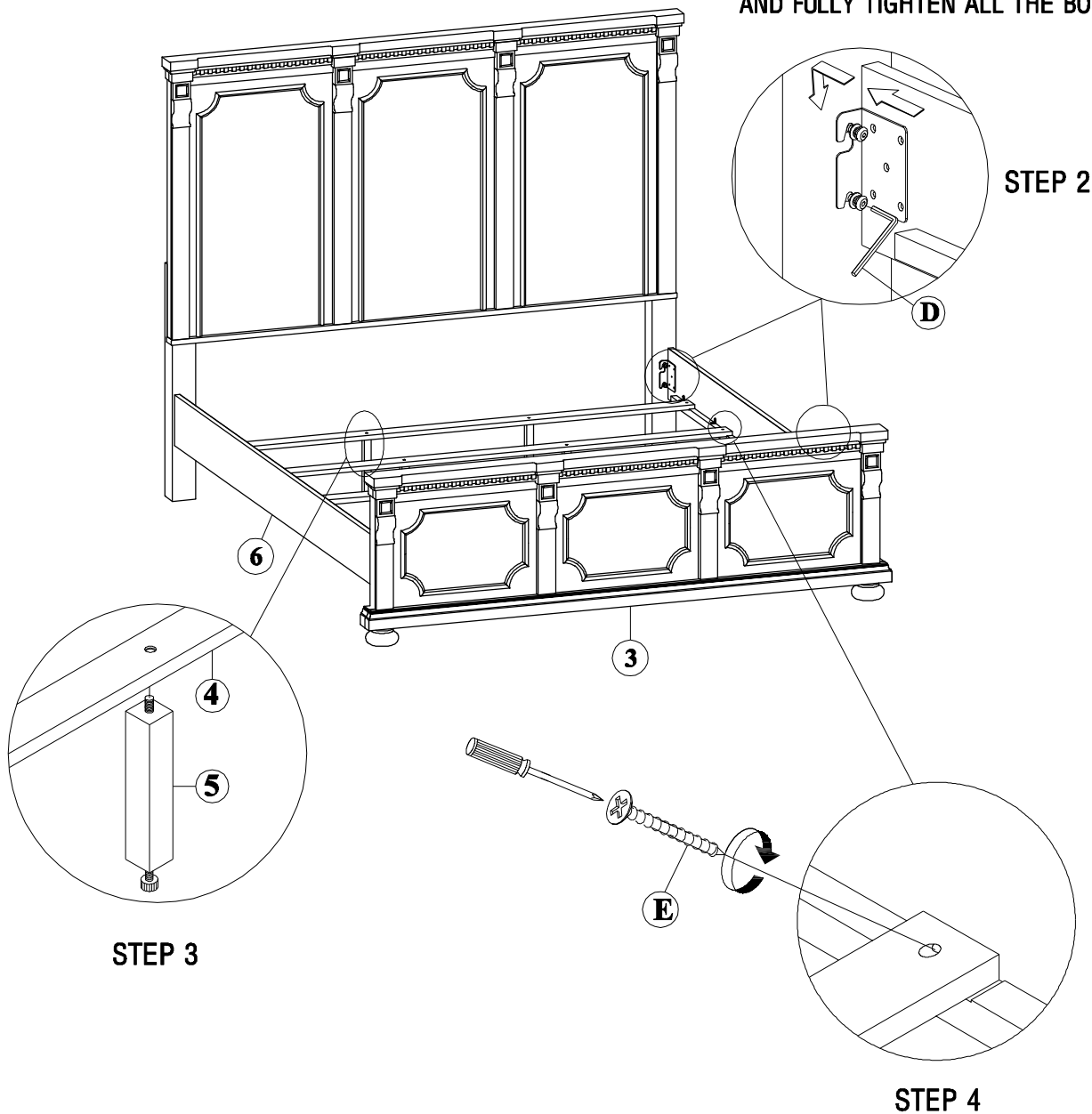



LIVING SPACES

REPLACEMENT PARTS

ITEM 305-P335160 / 161 / 152

6/6 BED



x1 RP335150-LEGR
Right Leg

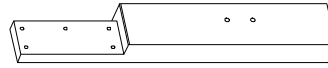

x1 RP335150-LEGL
Left Leg

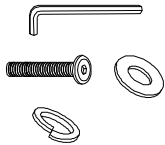

x1 RP335150-HWKIT
Hardware Kit

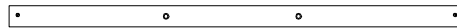

x5 RP335161-SLAT
Slat

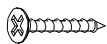

x10 RP335151-SCREW
Screw

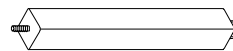

x10 RP335151-SULEG
Slat Support Leg

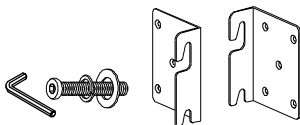

x1 RP335152-BRACKET
Bracket with Hardware