













# MARTIN® FURNITURE

SET-UP INSTRUCTIONS FOR ITEM  
IMK0380 KOMODO CONSOLE  
info@martinfurniture.com

NO:	Parts List		Q'TY
A		TV Console	1 PC
B		Adjustable shelf	2 PCS
C		Left front and Right back Legs ( OAK )	2 PCS
D		Right front and Left back Legs ( OAK )	2 PCS
E		Center support leg (OAK)	1 PC
F		Shelf Pin	8 PCS
G		Screw Ø 8 * 15mm	8 PCS

NO:	Hardware List		Q'TY
1		Furniture Tipping Restraint	1 PC
2		Bolt Ø 5/16" * 1-3/4"	6 PCS
3		Spring Washer Ø 5/16" * 12 *1.1mm	6 PCS
4		Flat Washer Ø 5/16" * 19 * 2mm	6 PCS
5		Allen Wrench (4mm)	1 PC
6		Dowels	2 PCS

Caution: Please read all instructions before assembly and check the carton for any parts that may have come loose during shipment. It is recommended to use two or more people during the assembly process.

1

Install legs (C) (D) at each corner of the console (A) and secure in place using a bolt (2) with spring washer (3) and flat washer (4). Adjust levelers if needed.

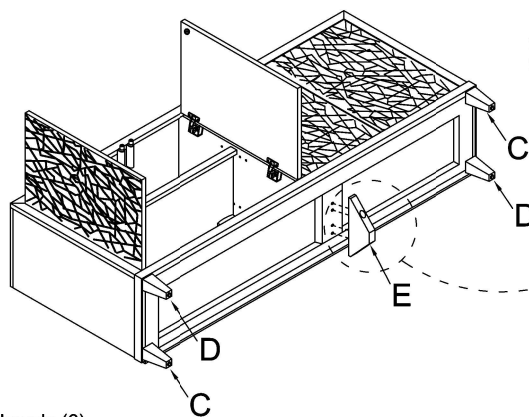
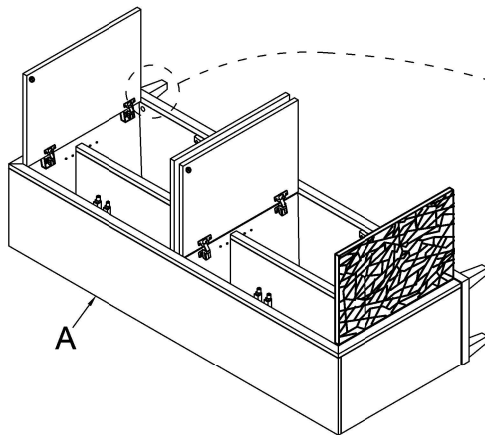

2

Install center support leg (E) and secure in place using dowels (6) and bolt (2) with spring washer (3) and flat washer (4). Adjust levelers if needed.

## CARING FOR YOUR FURNITURE

- Use a soft, clean cloth that will not scratch the surface when dusting.
- Use of furniture polishes are not necessary. Should you choose to use polishes, test in an inconspicuous area first.
- Using solvents of any kind on your furniture may damage your furniture finish.
- Never use water to clean your furniture as it may cause damage to the finish.
- Always use coasters under beverage glasses and flowerpots.
- Liquid spills should be removed immediately. Use a soft, clean cloth, blot the spill gently. Avoid rubbing.
- Direct sunlight may damage wood finishes.
- Extreme temperature and humidity changes can cause warping, shrinking and splitting of wood furniture. It is best to keep furniture in a climate controlled environment.
- Always use protective pads under hot dishes and plates. Heat can cause chemical changes that may create spotting within the furniture finish.
- In the event that your furniture is stained or otherwise damaged during use, we recommend that you call a professional to repair your furniture.

3

The Shelves (B) are secured in place with screws (G) through a metal shelf pin (F) for packing and shipping. To adjust shelf height, loosen the screws and remove the shelf and the shelf pins. Position the shelf pins at desired height, place the shelf on the shelf pins and tighten with screws as shown in the illustration.

**Tool Required: Philip Screw Driver ( not provided )**

4

Anti-tip hardware kit must always be used to prevent the unit from tipping. Attach anti-tip restraint at top of the console.

Regarding detail instruction of Anti-tip kindly reference AI in the anti-tip kit

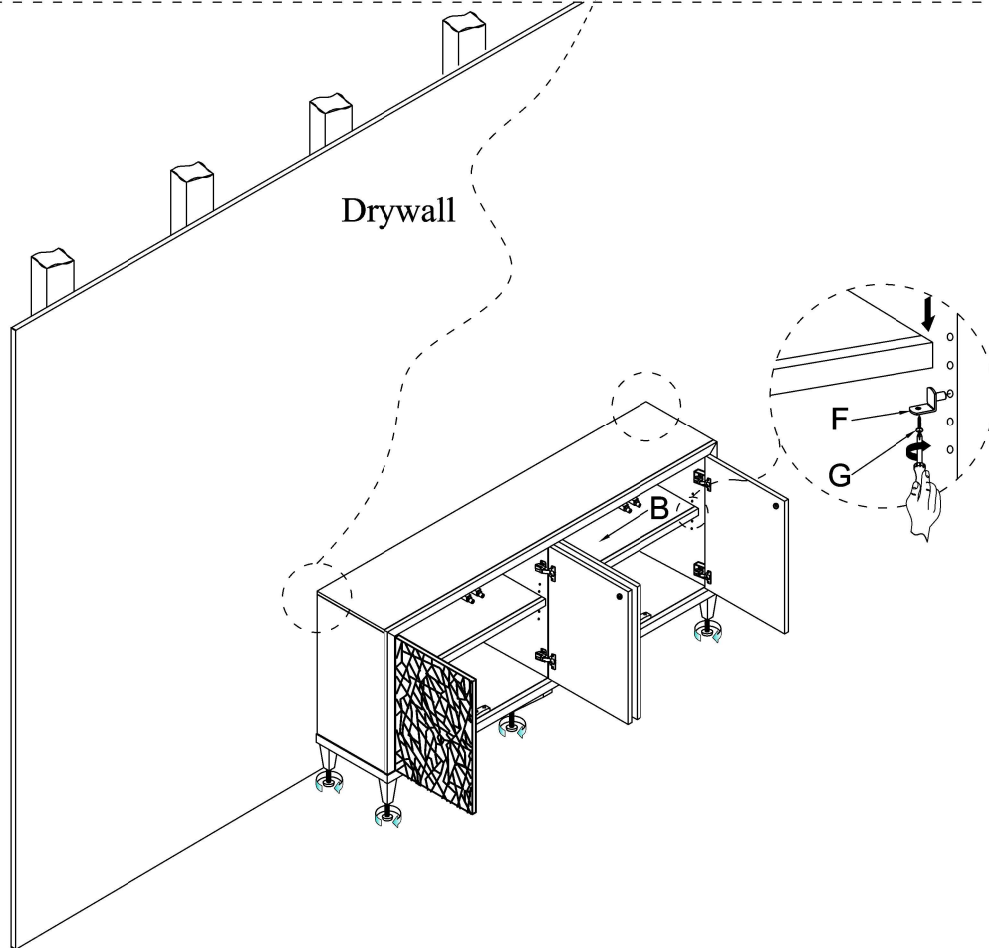
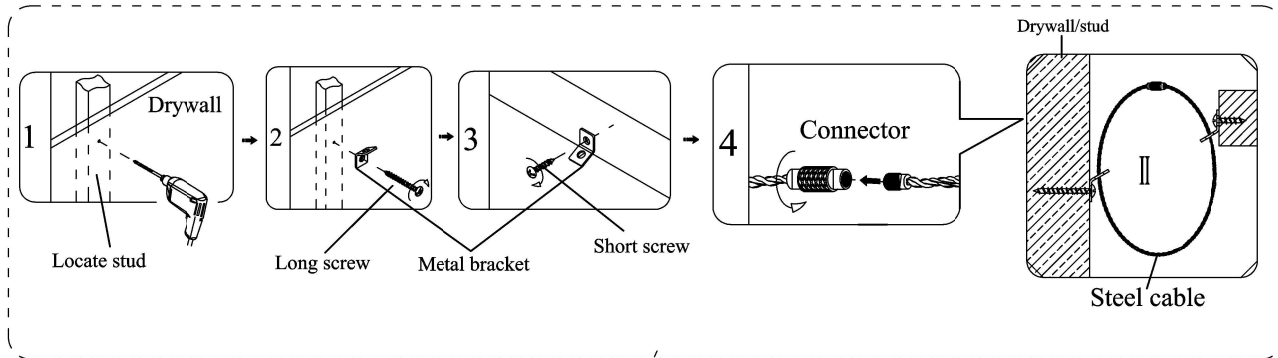

Note: Adjust the leg levelers as needed.

### CARING FOR YOUR FURNITURE

- Use a soft, clean cloth that will not scratch the surface when dusting.
- Use of furniture polishes are not necessary. Should you choose to use polishes, test in an inconspicuous area first.
- Using solvents of any kind on your furniture may damage your furniture finish.
- Never use water to clean your furniture as it may cause damage to the finish.
- Always use coasters under beverage glasses and flowerpots.
- Liquid spills should be removed immediately. Use a soft, clean cloth, blot the spill gently. Avoid rubbing.
- Direct sunlight may damage wood finishes.
- Extreme temperature and humidity changes can cause warping, shrinking and splitting of wood furniture. It is best to keep furniture in a climate controlled environment.
- Always use protective pads under hot dishes and plates. Heat can cause chemical changes that may create spotting within the furniture finish.
- In the event that your furniture is stained or otherwise damaged during use, we recommend that you call a professional to repair your furniture.