





ASSEMBLY INSTRUCTION FOR PLATFORM KING BASE BED

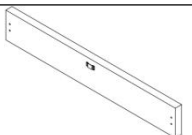

UBB102KBBO/UBB101KBBO/UBB082KBBO

Caution: Please read instructions thoroughly before unpacking assembly parts. Sharp, exposed staple tips can cause injury, therefore, for your protection, please remove any exposed staples used in packing.

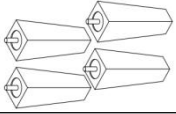
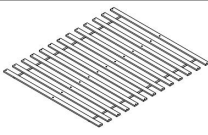
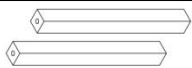
We recommend that you should assemble this product with the assistance of another person; this will make assembly easier, and help to eliminate damage to the product or injury to the persons during assembly.

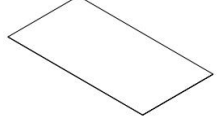
1. Be sure to check all packing materials carefully for small parts that may have come loose inside the carton during shipment.
2. Please do not over tighten screws or bolts.
3. Please put all parts on a non-abrasive floor before assembly, and follow the assembly steps to assemble your newly purchased product correctly and efficiently.

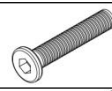
PART LIST				
NO	SKETCH	PART DESC	PART CODE	QTY
A		Headboard		1 pcs
B		Footboard		1 pcs
C		Side rail		2 pcs
D		Leg	PUBB.BBO.BDLEG	4 pcs
E		Slat (Pce)	PUBB.KBBO.SLT	1 pcs
F		Slat support leg (Pce)	PUBB.BBO.BDSPL	2 pcs
G		Center rail		1 pcs
H		Bed Cover		1pcs

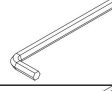
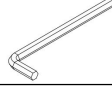
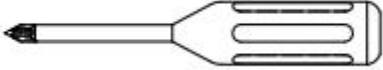
HARDWARE LIST				
NO.	SKETCH	HARDWARE DESC	PART CODE	QTY
1		JCBB M8 x 25 mm	PUBB.BBO.HW	8 pcs
2		JCBC M6 x 50 mm		2 pcs
3		Screw M4 x 30 mm		8 pcs
4		Allen key M6 x 57 mm		1 pcs
5		Allen key M8 x 67 mm		1 pcs
		PHILIPS SCREWDRIVER REQUIRED (NOT INCLUDED)		

ASSEMBLY INSTRUCTION FOR PLATFORM KING BASE BED

UBB102KBBO/UBB101KBBO/UBB082KBBO

STEP 1:

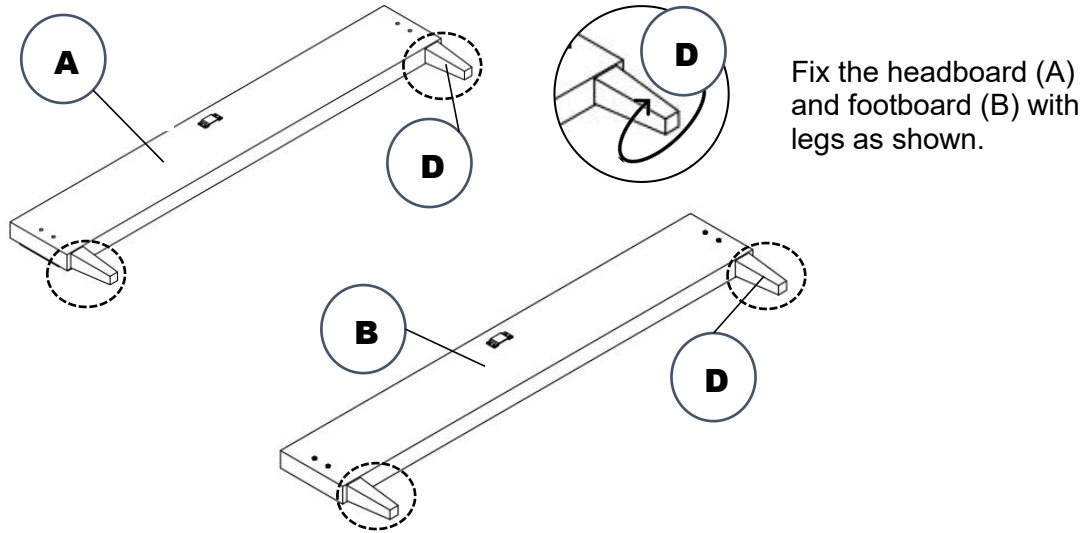

STEP 2:

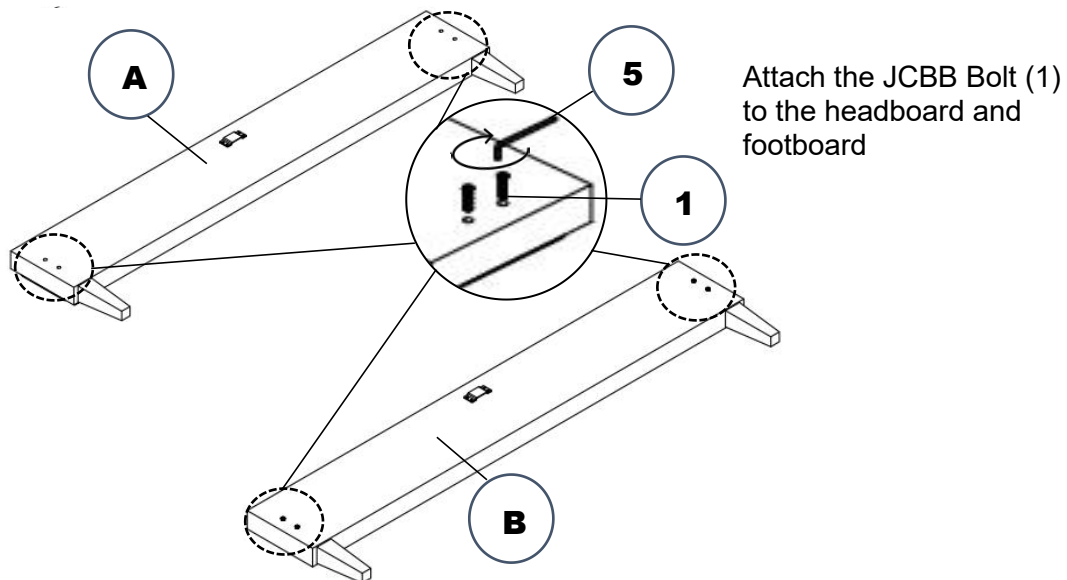

ASSEMBLY INSTRUCTION FOR PLATFORM KING BASE BED

UBB102KBBO/UBB101KBBO/UBB082KBBO

STEP 3:

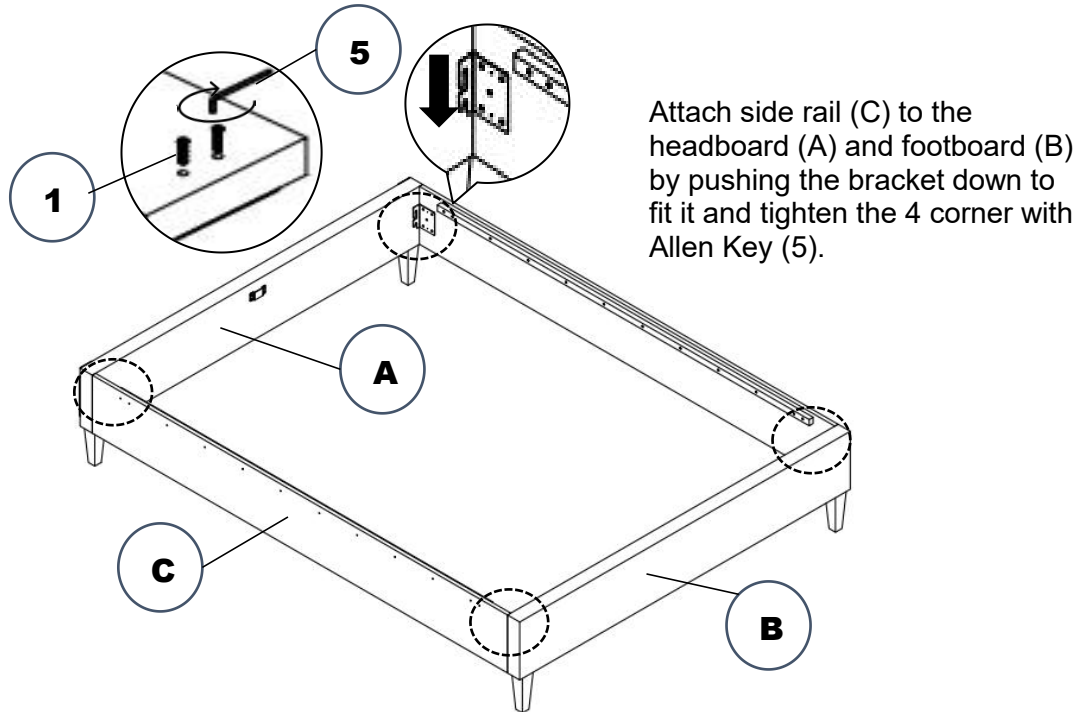

STEP 4:

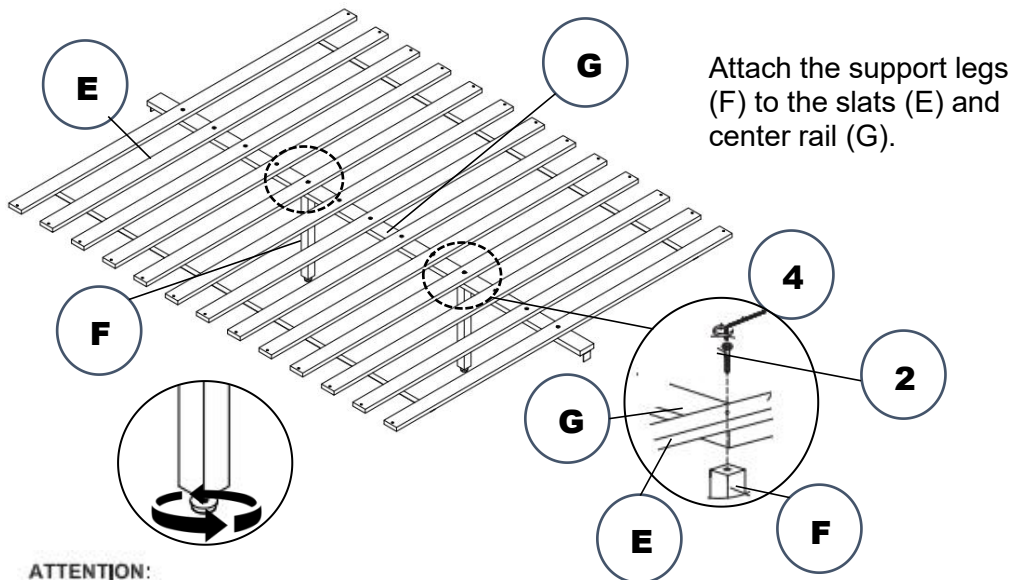

ATTENTION:
Please keep the adjuster around 5 to 8 mm distant away from the floor.

ASSEMBLY INSTRUCTION FOR PLATFORM KING BASE BED

UBB102KBBO/UBB101KBBO/UBB082KBBO

STEP 5:

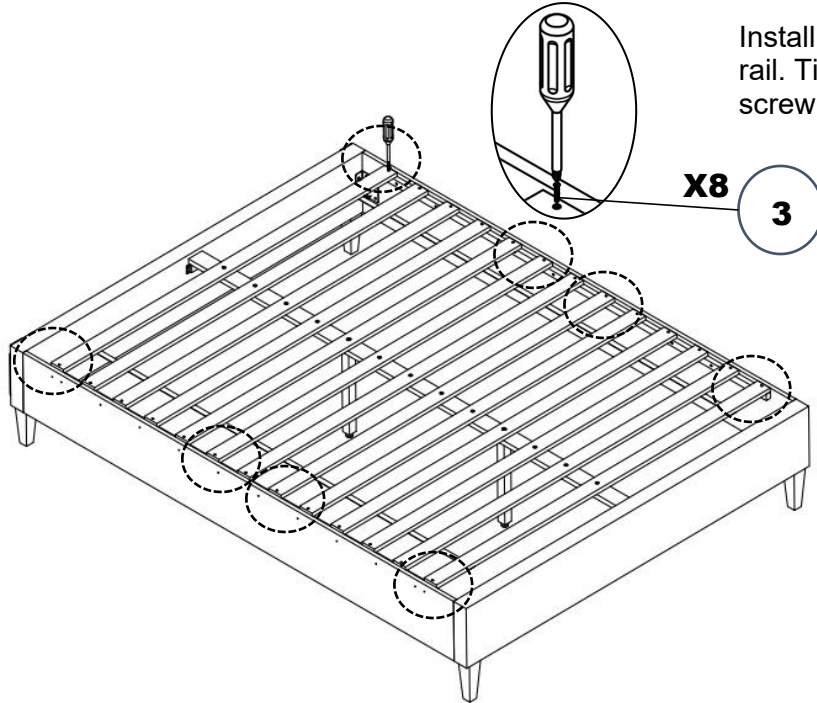

COMPLETED:

