







PRODUCT ASSEMBLY INSTRUCTIONS

ITEM: EDY SWIVEL BARSTOOL

Helpers needed to assemble: 1

Estimated time frame to assemble: 15 minutes

I, PARTS LIST:

#	Picture	DESCRIPTIONS	Quantity
A		BARSTOOL SEAT	1
B		BARSTOOL BASE	1
C		SCREW 1/4"-20 PPH 3/4"	4
D		LOCK WASHER	4
E		FLAT WASHER	4
F		DUEL HEX WRENCH WITH CROSSHEAD	1

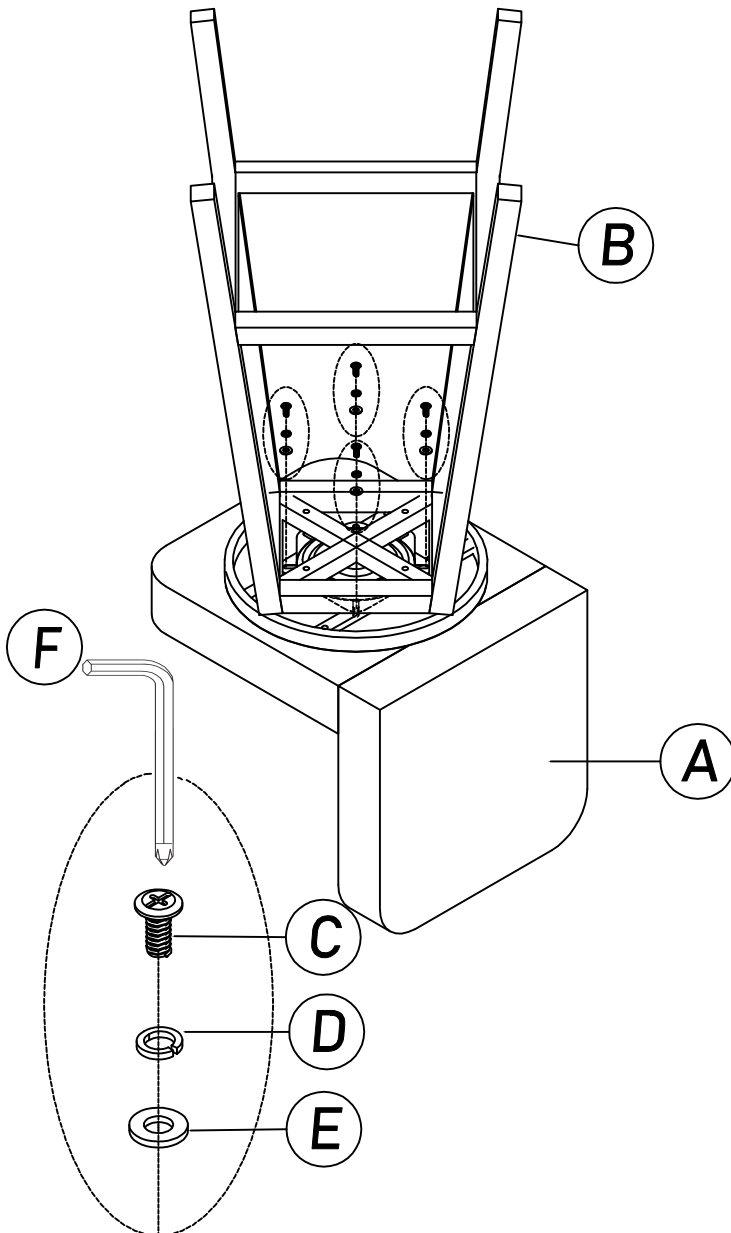

II, INSTALLATIONS:

1. PLACE THE SEAT(A) UPSIDE DOWN ON A PADDED OR CARPETED SURFACE, MAKE SURE THE SEAT IS FACING THE FRONT. DO NOT REMOVE ANY PROTECTION PACKAGE AT THIS TIME.
2. TURN THE BASE UPSIDE DOWN, MAKE SURE THE FOOTREST IS FACING, THE FRONT. POSITION THE TOP PLATE OF THE SWIVEL AGAINST THE STOPPERS ON THE TWO BARS (AS SHOWN)
3. PRESS THE BASE DOWN AND TURNIT TO -45° (CLOCKWISE)UNTIL YOU CAN MATCH THE HOLES OF THE SWIVEL WITH THE HOLES OF THE TWO BARS UNDERNEATH THE SEAT.
4. FINGER TIGHTEN 4 SCREWS (C) WITH LOCK WASHERS (D), AND THE FLAT WASHER TO THE HOLES ON THE SEAT, AS SHOWN. (IF YOU FACE THE FRONT OF THE BARSTOOL),
5. TIGHTEN ALL 4 SCREWS (C) WITH THE CROSSHEAD SIDE OF HEX TOOL
6. RELEASE YOUR HAND SO THE BASE CAN RETURN AND FACE THE FRONT AGAIN.
7. TURN THE BARSTOOL UPRIGHT, CAREFULLY REMOVE THE PROTECTION PACKAGES.
8. TURNED THE SEAT TO LEFT AND RIGHT A FEW TIMES, NOW THE BARSTOOL IS READY TO BE USED.

Product Assembly Instructions





Item#: EDY SWIVEL BARSTOOL

Helpers needed to assemble: 1

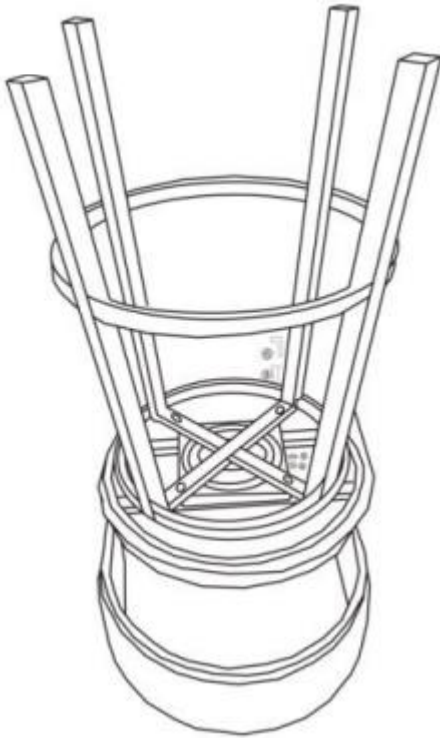
Estimate time frame to assemble: 15 minutes

Tools Needed: Phillips Head Screwdriver



#	Picture	Description	Quantity
1		Barstool Seat	1
2		Barstool Base	1
3		Screws 1/4-20 PPH 3/4"	1
4		Lock Washer	4
5		Flat Washer	4

- **Step 1:** Place the Seat upside down on the floor as seen, make sure the seat is facing front..
- **Step 2:** Turn the base upside, wit the footrest facing the front. Position the top plate of the swivel against the stoppers on the two bars.
- **Step 3** :Press the base down an turn 45 degrees clockwise until the holes of the swivel match the holes of the bar.
- **Step 4:** Finger tighten the 4 screws along with the lock washers and the flat washers to the holes of the seat.

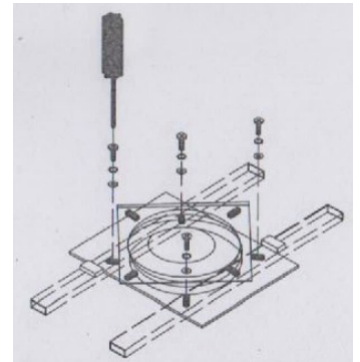

- **Step 5:** Tighten all 4 screws with a Phillips Head screwdriver.
- **Step 6:** Release the base and allow it to return and face the front.
- **Step 7:** Turn the barstool upright and remove all packaging. Sit and enjoy your new barstool.