

\*LAST UPDATED 05/23/24

First Name: \_\_\_\_\_ Last Name: \_\_\_\_\_

Customer Signature: \_\_\_\_\_ Date: \_\_\_\_\_

Sales Person Name: \_\_\_\_\_

Sale Order Number: \_\_\_\_\_

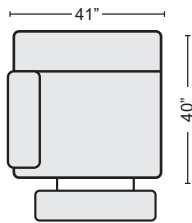
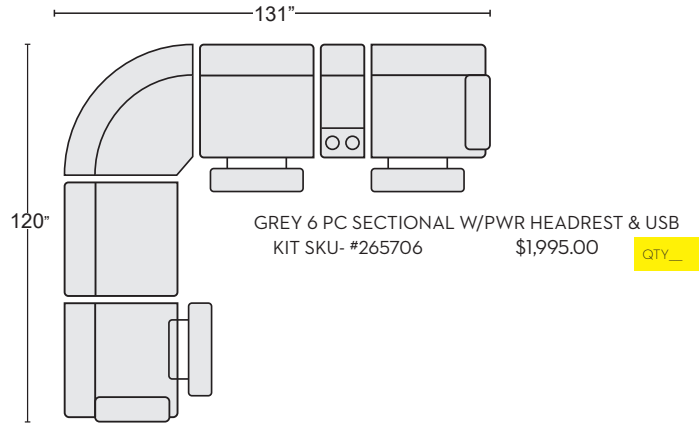

GREY LAF PWR RECL W/USB & POWER HEADREST  
#263121 \$490.00 QTY\_

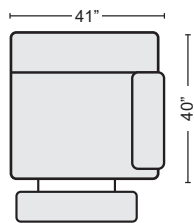

GREY RAF PWR RECL W/USB & POWER HEADREST  
#263124 \$490.00 QTY\_

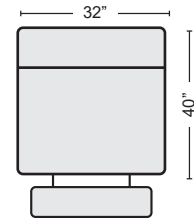

GREY ARMLESS RECLINER  
#228292 \$300.00 QTY\_

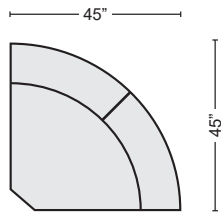

GREY WEDGE  
#228309 \$345.00 QTY\_

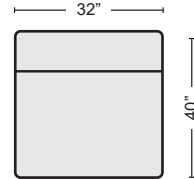

GREY ARMLESS CHAIR  
#228306 \$225.00 QTY\_

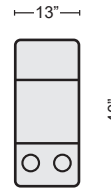

GREY CONSOLE W/USB  
#228313 \$145.00 QTY\_